

DEWALT®

www.DEWALT.com

DCS355

Dansk (<i>oversat fra original brugsvejledning</i>)	5
Deutsch (<i>übersetzt von den originalanweisungen</i>)	19
English (<i>original instructions</i>)	35
Español (<i>traducido de las instrucciones originales</i>)	49
Français (<i>traduction de la notice d'instructions originale</i>)	65
Italiano (<i>tradotto dalle istruzioni originali</i>)	81
Nederlands (<i>vertaald vanuit de originele instructies</i>)	97
Norsk (<i>oversatt fra de originale instruksjonene</i>)	113
Português (<i>traduzido das instruções originais</i>)	127
Suomi (<i>käännetty alkuperäisestä käyttöohjeesta</i>)	143
Svenska (<i>översatt från de ursprungliga instruktionerna</i>)	157
Türkçe (<i>orijinal talimatlardan çevrilmiştir</i>)	171
Ελληνικά (<i>μετάφραση από τις πρωτότυπες οδηγίες</i>)	186

Figure 1

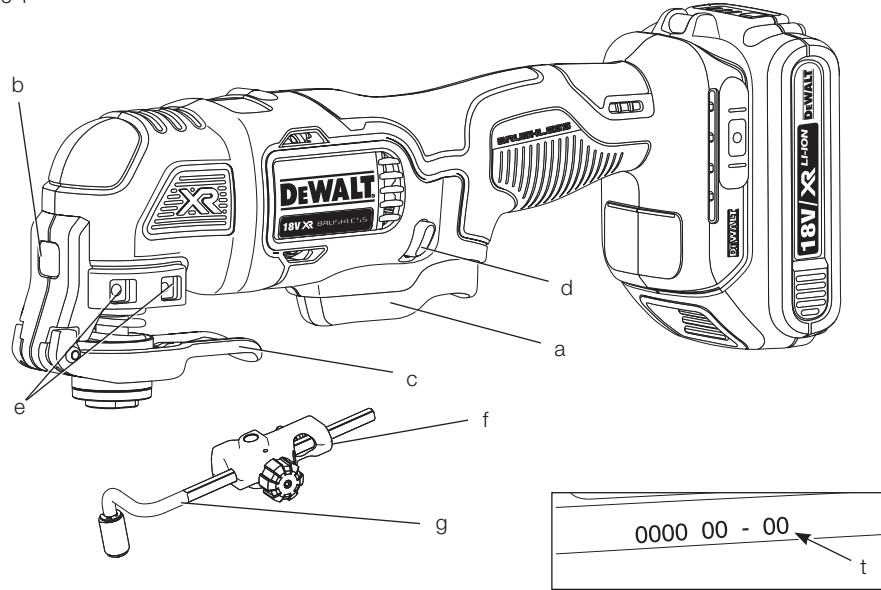

Figure 2

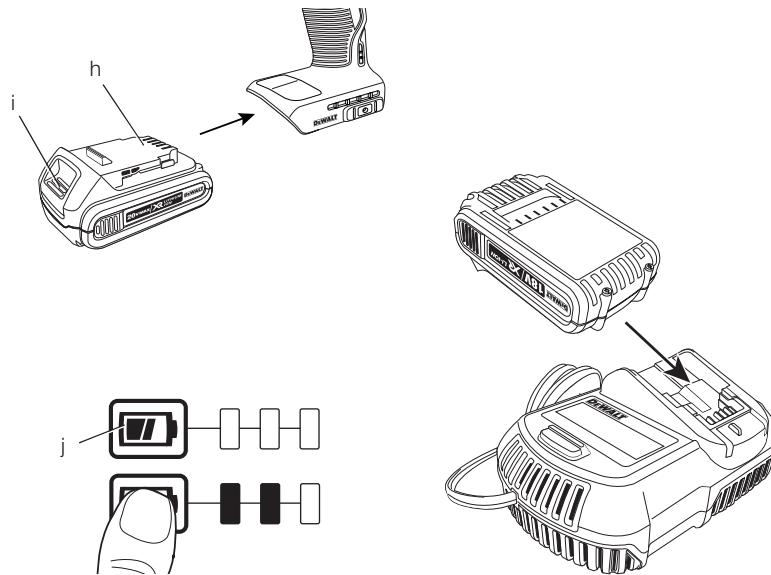

Figure 3

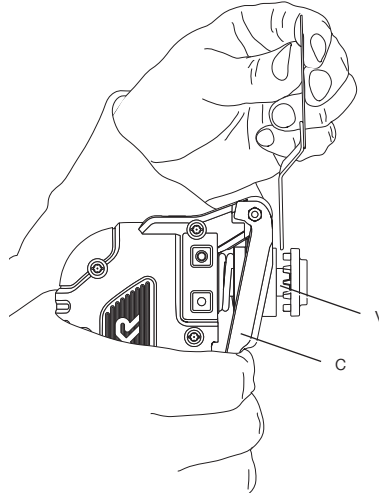

Figure 4

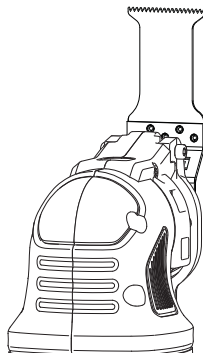

Figure 5

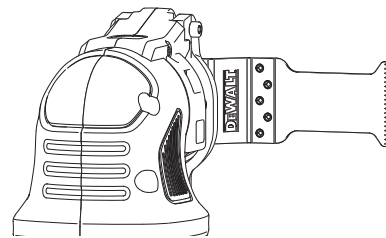

Figure 6

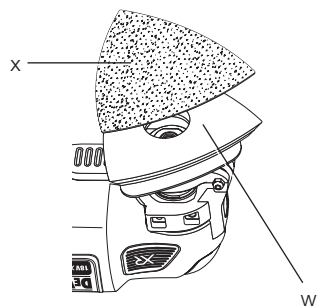

Figure 7

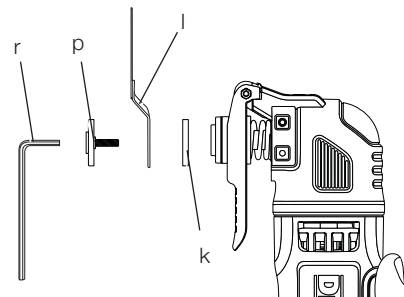

Figure 8

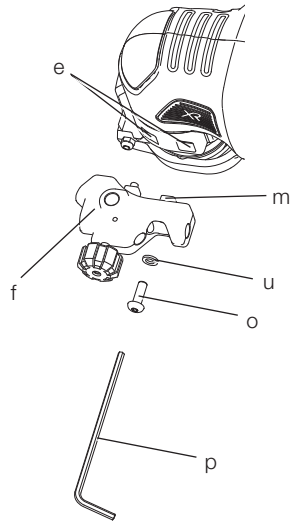

Figure 9

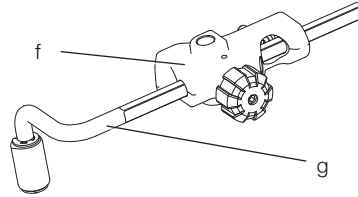

Figure 10

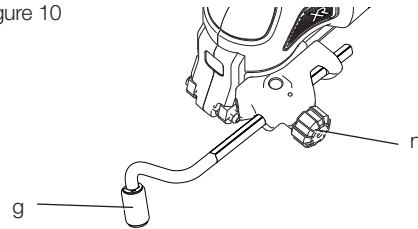

Figure 11

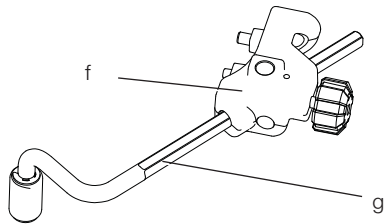

Figure 12

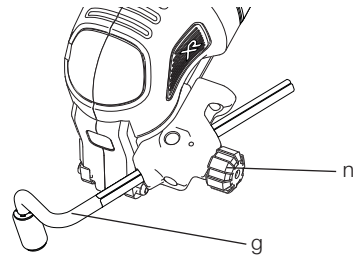

Figure 13

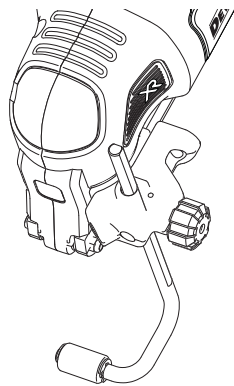

Figure 14

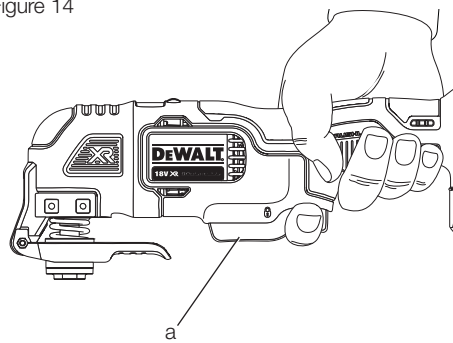

Figure 15

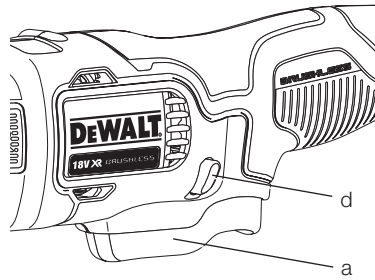

Figure 16

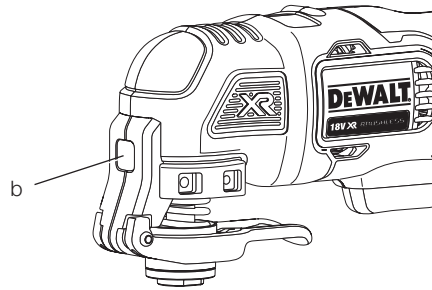

Figure 17

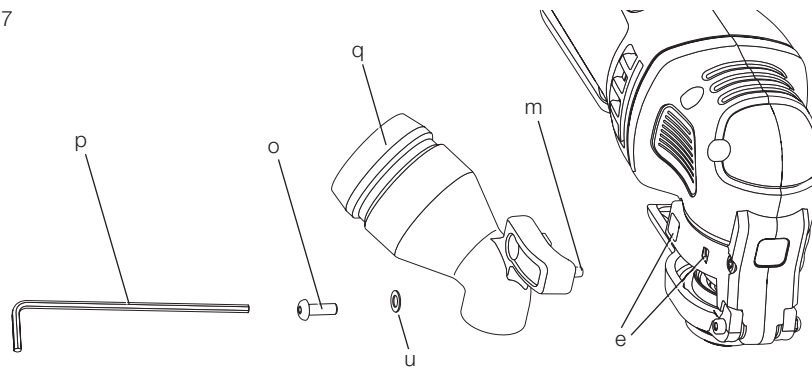

Figure 18

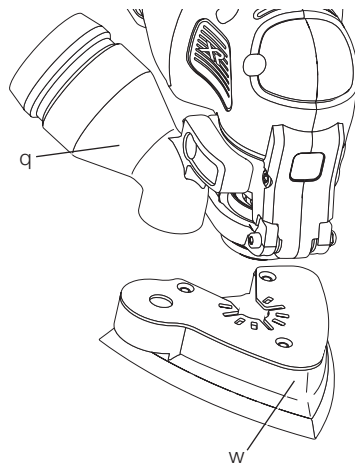
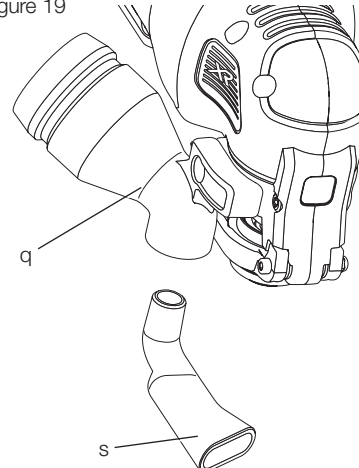

Figure 19



CORDLESS OSCILLATING MULTI-TOOL

DCS355

Congratulations!

You have chosen a DEWALT tool. Years of experience, thorough product development and innovation make DEWALT one of the most reliable partners for professional power tool users.

Technical Data

		DCS355
Voltage	V_{DC}	18
Type		1
Battery Type		Li-Ion
Power input	W	300
Power output	W	170
Oscillating frequency	min ⁻¹	0–20 000
Oscillating angle		1.6°
Weight	kg	1.1
L_{PA} (sound pressure)	dB(A)	86
K_{PA} (sound pressure uncertainty)	dB(A)	3
L_{WA} (sound power)	dB(A)	97
K_{WA} (sound power uncertainty)	dB(A)	3

Vibration total values (triax vector sum) determined according to EN 60745:

Vibration emission value a_h		
$a_h =$	m/s ²	16.1
Uncertainty K =	m/s ²	1.5

The vibration emission level given in this information sheet has been measured in accordance with a standardised test given in EN 60745 and may be used to compare one tool with another. It may be used for a preliminary assessment of exposure.



WARNING: The declared vibration emission level represents the main applications of the tool. However if the tool is used for different applications, with different accessories or poorly maintained, the vibration emission may differ. This may significantly increase the exposure level over the total working period.

An estimation of the level of exposure to vibration should also take into account the times when the tool is switched off or when it is running but not actually doing the job. This may significantly reduce the exposure level over the total working period.

Identify additional safety measures to protect the operator from the effects of vibration such as: maintain the tool and the accessories, keep the hands warm, organisation of work patterns.

Battery pack		DCB180	DCB181	DCB182	DCB183
Battery type		Li-Ion	Li-Ion	Li-Ion	Li-Ion
Voltage	V_{DC}	18	18	18	18
Capacity	A_h	3.0	1.5	4.0	2.0
Weight	kg	0.64	0.35	0.61	0.40

Charger		DCB105			
Mains voltage		V_{AC} 230 V			
Battery type		Li-Ion			
Approx. charging time	min	30 (1.5 Ah battery packs)	40 (2.0 Ah battery packs)	55 (3.0 Ah battery packs)	70 (4.0 Ah battery packs)
Weight	kg	0.49			

ENGLISH

Fuses		
Europe	230 V tools	10 Amperes, mains
U.K. & Ireland	230 V tools	13 Amperes, in plugs

Definitions: Safety Guidelines

The definitions below describe the level of severity for each signal word. Please read the manual and pay attention to these symbols.



DANGER: Indicates an imminently hazardous situation which, if not avoided, **will result in death or serious injury.**



WARNING: Indicates a potentially hazardous situation which, if not avoided, **could result in death or serious injury.**



CAUTION: Indicates a potentially hazardous situation which, if not avoided, **may result in minor or moderate injury.**

NOTICE: Indicates a practice **not related to personal injury** which, if not avoided, **may result in property damage.**



Denotes risk of electric shock.



Denotes risk of fire.

EC-Declaration of Conformity

MACHINERY DIRECTIVE



DCS355

DEWALT declares that these products described under **Technical Data** are in compliance with: 2006/42/EC, EN 60745-1, EN60745-2-4, EN60745-2-11.

These products also comply with Directive 2004/108/EC and 2011/65/EU. For more information, please contact DEWALT at the following address or refer to the back of the manual.

The undersigned is responsible for compilation of the technical file and makes this declaration on behalf of DEWALT.

H. Grossmann

Horst Grossmann
Vice President Engineering and
Product Development
DEWALT, Richard-Klinger-Strasse 11,
D-65510, Idstein, Germany
03.07.2013



WARNING: To reduce the risk of injury, read the instruction manual.

General Power Tool Safety Warnings



WARNING! Read all safety warnings and all instructions. Failure to follow the warnings and instructions may result in electric shock, fire and/or serious injury.

SAVE ALL WARNINGS AND INSTRUCTIONS FOR FUTURE REFERENCE

The term "power tool" in the warnings refers to your mains-operated (corded) power tool or battery-operated (cordless) power tool.

1) WORK AREA SAFETY

- Keep work area clean and well lit.** Cluttered or dark areas invite accidents.
- Do not operate power tools in explosive atmospheres, such as in the presence of flammable liquids, gases or dust.** Power tools create sparks which may ignite the dust or fumes.
- Keep children and bystanders away while operating a power tool.** Distractions can cause you to lose control.

2) ELECTRICAL SAFETY

- Power tool plugs must match the outlet. Never modify the plug in any way. Do not use any adapter plugs with earthed (grounded) power tools.** Unmodified plugs and matching outlets will reduce risk of electric shock.
- Avoid body contact with earthed or grounded surfaces such as pipes, radiators, ranges and refrigerators.** There is an increased risk of electric shock if your body is earthed or grounded.
- Do not expose power tools to rain or wet conditions.** Water entering a power tool will increase the risk of electric shock.
- Do not abuse the cord. Never use the cord for carrying, pulling or unplugging the power tool. Keep cord away from heat, oil, sharp edges or moving parts.** Damaged or entangled cords increase the risk of electric shock.

- e) **When operating a power tool outdoors, use an extension cord suitable for outdoor use.** Use of a cord suitable for outdoor use reduces the risk of electric shock.
- f) **If operating a power tool in a damp location is unavoidable, use a residual current device (RCD) protected supply.** Use of an RCD reduces the risk of electric shock.

3) PERSONAL SAFETY

- a) **Stay alert, watch what you are doing and use common sense when operating a power tool. Do not use a power tool while you are tired or under the influence of drugs, alcohol or medication.** A moment of inattention while operating power tools may result in serious personal injury.
- b) **Use personal protective equipment. Always wear eye protection.** Protective equipment such as dust mask, non-skid safety shoes, hard hat, or hearing protection used for appropriate conditions will reduce personal injuries.
- c) **Prevent unintentional starting. Ensure the switch is in the off position before connecting to power source and/or battery pack, picking up or carrying the tool.** Carrying power tools with your finger on the switch or energising power tools that have the switch on invites accidents.
- d) **Remove any adjusting key or wrench before turning the power tool on.** A wrench or a key left attached to a rotating part of the power tool may result in personal injury.
- e) **Do not overreach. Keep proper footing and balance at all times.** This enables better control of the power tool in unexpected situations.
- f) **Dress properly. Do not wear loose clothing or jewellery. Keep your hair, clothing and gloves away from moving parts.** Loose clothes, jewellery or long hair can be caught in moving parts.
- g) **If devices are provided for the connection of dust extraction and collection facilities, ensure these are connected and properly used.** Use of dust collection can reduce dust-related hazards.

4) POWER TOOL USE AND CARE

- a) **Do not force the power tool. Use the correct power tool for your application.** The correct power tool will do the job better and safer at the rate for which it was designed.

- b) **Do not use the power tool if the switch does not turn it on and off.** Any power tool that cannot be controlled with the switch is dangerous and must be repaired.
- c) **Disconnect the plug from the power source and/or the battery pack from the power tool before making any adjustments, changing accessories, or storing power tools.** Such preventive safety measures reduce the risk of starting the power tool accidentally.
- d) **Store idle power tools out of the reach of children and do not allow persons unfamiliar with the power tool or these instructions to operate the power tool.** Power tools are dangerous in the hands of untrained users.
- e) **Maintain power tools. Check for misalignment or binding of moving parts, breakage of parts and any other condition that may affect the power tool's operation. If damaged, have the power tool repaired before use.** Many accidents are caused by poorly maintained power tools.
- f) **Keep cutting tools sharp and clean.** Properly maintained cutting tools with sharp cutting edges are less likely to bind and are easier to control.
- g) **Use the power tool, accessories and tool bits etc., in accordance with these instructions taking into account the working conditions and the work to be performed.** Use of the power tool for operations different from those intended could result in a hazardous situation.

5) BATTERY TOOL USE AND CARE

- a) **Recharge only with the charger specified by the manufacturer.** A charger that is suitable for one type of battery pack may create a risk of fire when used with another battery pack.
- b) **Use power tools only with specifically designated battery packs.** Use of any other battery packs may create a risk of injury and fire.
- c) **When battery pack is not in use, keep it away from other metal objects like paper clips, coins, keys, nails, screws or other small metal objects that can make a connection from one terminal to another.** Shorting the battery terminals together may cause burns or a fire.
- d) **Under abusive conditions, liquid may be ejected from the battery, avoid contact. If contact accidentally occurs, flush with water. If liquid contacts eyes, additionally seek medical help.** Liquid ejected from the battery may cause irritation or burns.

6) SERVICE

- a) **Have your power tool serviced by a qualified repair person using only identical replacement parts.** This will ensure that the safety of the power tool is maintained.

Additional Safety Rules for Oscillating Multi-Tool



WARNING: Take special care when sanding some woods (e.g. beech, oak) and metal which may produce toxic dust. Wear a dust mask specifically designed for protection against toxic dust and fumes and ensure that persons within or entering the work area are also protected.



WARNING: Use this tool in a well-ventilated area when sanding ferrous metals. Do not operate the tool near flammable liquids, gases or dust. Sparks or hot particles from sanding or arcing motor brushes may ignite combustible materials.

Sanding Paint



WARNING: Observe the applicable regulations for sanding paint. Pay special attention to the following:

- Whenever possible, use a vacuum extractor for dust collection.
- Take special care when sanding paint which is possibly lead based:
 - Do not let children or pregnant women enter the work area.
 - All persons entering the work area should wear a mask specially designed for protection against lead paint dust and fumes.
 - Do not eat, drink or smoke in the work area.
- Dispose of dust particles and any other removal debris safely.
- **Hold power tool by insulated gripping surfaces when performing an operation where the cutting tool may contact hidden wiring or its own cord.** Contact with a "live" wire will make exposed metal parts of the tool "live" and shock the operator.
- **Use clamps or another practical way to secure and support the workpiece to a stable platform.** Holding the work by hand or against your body leaves it unstable and may lead to loss of control.

Residual Risks

In spite of the application of the relevant safety regulations and the implementation of safety devices, certain residual risks cannot be avoided. These are:

- Impairment of hearing.
- Risk of personal injury due to flying particles.
- Risk of burns due to accessories becoming hot during operation.
- Risk of personal injury due to prolonged use.

Markings on Tool

The following pictograms are shown on the tool:



Read instruction manual before use.



Wear ear protection.



Wear eye protection.



Wear respiratory protection.

DATE CODE POSITION (FIG. 1)

The date code (t), which also includes the year of manufacture, is printed into the housing.

Example:

2013 XX XX

Year of Manufacture

Important Safety Instructions for All Battery Chargers

SAVE THESE INSTRUCTIONS: This manual contains important safety and operating instructions for the DCB105 battery charger.

- Before using the charger, read all instructions and cautionary markings on charger, battery pack and product using the battery pack.



WARNING: Shock hazard. Do not allow any liquid to get inside charger. Electric shock may result.



CAUTION: Burn hazard. To reduce the risk of injury, charge only DEWALT rechargeable battery packs. Other types of batteries may overheat and burst resulting in personal injury and property damage.



CAUTION: Children should be supervised to ensure that they do not play with the appliance.

NOTICE: Under certain conditions, with the charger plugged in to the power supply, the exposed charging contacts inside the charger can be shorted by foreign material. Foreign materials of a conductive nature such as, but not limited to, steel wool, aluminium foil or any buildup of metallic particles should be kept away from charger cavities. Always unplug the charger from the power supply when there is no battery pack in the cavity. Unplug charger before attempting to clean.

- **DO NOT attempt to charge the battery pack with any chargers other than the ones in this manual.** The charger and battery pack are specifically designed to work together.
- **These chargers are not intended for any uses other than charging DEWALT rechargeable batteries.** Any other uses may result in risk of fire, electric shock or electrocution.
- **Do not expose charger to rain or snow.**
- **Pull by plug rather than cord when disconnecting charger.** This will reduce risk of damage to electric plug and cord.
- **Make sure that cord is located so that it will not be stepped on, tripped over or otherwise subjected to damage or stress.**
- **Do not use an extension cord unless it is absolutely necessary.** Use of improper extension cord could result in risk of fire, electric shock or electrocution.
- **When operating a charger outdoors, always provide a dry location and use an extension cord suitable for outdoor use.** Use of a cord suitable for outdoor use reduces the risk of electric shock.
- **Do not block the ventilation slots on the charger. The ventilation slots are located on the top and sides of the charger.** Place the charger in a position away from any heat source.
- **Do not operate charger with damaged cord or plug — have them replaced immediately.**
- **Do not operate charger if it has received a sharp blow, been dropped or otherwise damaged in any way.** Take it to an authorised service centre.
- **Do not disassemble the charger; take it to an authorised service centre when service or repair is required.** Incorrect reassembly may result in a risk of electric shock, electrocution or fire.
- **In case of damaged power supply cord the supply cord must be replaced immediately by the manufacturer, its service agent or similar qualified person to prevent any hazard.**
- **Disconnect the charger from the outlet before attempting any cleaning. This will reduce the risk of electric shock.** Removing the battery pack will not reduce this risk.
- **NEVER attempt to connect 2 chargers together.**
- **The charger is designed to operate on standard 230 V household electrical power. Do not attempt to use it on any other voltage.** This does not apply to the vehicular charger.

SAVE THESE INSTRUCTIONS

Chargers

The DCB105 charger accepts 10.8 V, 14.4 V and 18 V Li-Ion (DCB123, DCB140, DCB141, DCB142, DCB143, DCB180, DCB181, DCB182 and DCB183) battery packs.

This charger requires no adjustment and is designed to be as easy as possible to operate.





Charging Procedure (fig. 2)

1. Plug the charger into an appropriate 230 V outlet before inserting the battery pack.
2. Insert the battery pack (h) into the charger, making sure the pack is fully seated in the charger. The red (charging) light will blink continuously indicating that the charging process has started.
3. The completion of charge will be indicated by the red light remaining ON continuously. The pack is fully charged and may be used at this time or left in the charger.

NOTE: To ensure maximum performance and life of Li-Ion batteries, charge the battery pack fully before first use.

Charging Process

Refer to the table below for the state of charge of the battery pack.

State of charge	
 charging	— — — —
 fully charged	—————
 hot/cold pack delay	— • — • — • — •
 problem pack or charger	• • • • • • • • • •
 problem powerline	• • • • • • • •

This charger will not charge a faulty battery pack. The charger will indicate faulty battery by refusing to light or by displaying problem pack or charger blink pattern.

NOTE: This could also mean a problem with a charger.

If the charger indicates a problem, take the charger and battery pack to be tested at an authorised service centre.

Hot/Cold Pack Delay

When the charger detects a battery that is too hot or too cold, it automatically starts a hot/cold pack delay, suspending charging until the battery has reached an appropriate temperature. The charger then automatically switches to the pack charging mode. This feature ensures maximum battery life.

XR Li-Ion tools are designed with an Electronic Protection System that will protect the battery against overloading, overheating or deep discharge.

The tool will automatically turn off if the Electronic Protection System engages. If this occurs, place the Li-Ion battery on the charger until it is fully charged.

A cold battery pack will charge at about half the rate of a warm battery pack. The battery pack will charge at that slower rate throughout the entire charging cycle and will not return to maximum charge rate even if the battery warms.

Important Safety Instructions for All Battery Packs

When ordering replacement battery packs, be sure to include the catalog number and voltage.

The battery pack is not fully charged out of the carton. Before using the battery pack and charger, read the safety instructions below and then follow the charging procedures outlined.

READ ALL INSTRUCTIONS

- **Do not charge or use the battery pack in explosive atmospheres, such as in the presence of flammable liquids, gases or dust.** Inserting or removing the battery pack from the charger may ignite the dust or fumes.
- **Never force the battery pack into charger. Do not modify the battery pack in any way to fit into a non-compatible charger as battery pack may rupture causing serious personal injury.**
- Charge the battery packs only in designated DEWALT chargers.
- **DO NOT** splash or immerse in water or other liquids.
- **Do not store or use the tool and battery pack in locations where the temperature may reach or exceed 40 °C (105 °F) (such as outside sheds or metal buildings in summer).**
- For best results, make sure the battery pack is fully charged before use.



WARNING: Never attempt to open the battery pack for any reason. If the battery pack case is cracked or damaged, do not insert it into the charger. Do not crush, drop or damage battery pack. Do not use a battery pack or charger that has received a sharp blow, been dropped, run over or damaged in any way (e.g., pierced with a nail, hit with a hammer, stepped on). Electric shock or electrocution may result. Damaged battery packs should be returned to the service centre for recycling.



CAUTION: When not in use, place tool on its side on a stable surface where it will not cause a tripping or falling hazard. Some tools with large battery packs will stand upright on the battery pack but may be easily knocked over.

SPECIFIC SAFETY INSTRUCTIONS FOR LITHIUM ION (Li-Ion)

- **Do not incinerate the battery pack even if it is severely damaged or is completely worn out.** The battery pack can explode in a fire. Toxic fumes and materials are created when lithium ion battery packs are burned.

- **If battery contents come into contact with the skin, immediately wash the area with mild soap and water.** If the battery liquid gets into the eye, rinse water over the open eye for 15 minutes or until irritation ceases. If medical attention is needed, the battery electrolyte is composed of a mixture of liquid organic carbonates and lithium salts.
- **Contents of opened battery cells may cause respiratory irritation.** Provide fresh air. If symptoms persists, seek medical attention.



WARNING: Burn hazard. Battery liquid may be flammable if exposed to spark or flame.

Battery Pack

BATTERY TYPE

The DCS355 operates on 18 volt XR Li-Ion battery packs.

The DCB180, DCB181, DCB182 or DCB183 battery packs may be used. Refer to **Technical Data** for more information.

Storage Recommendations

1. The best storage place is one that is cool and dry away from direct sunlight and excess heat or cold. For optimum battery performance and life, store battery packs at room temperature when not in use.
2. For long storage, it is recommended to store a fully charged battery pack in a cool, dry place out of the charger for optimal results.

NOTE: Battery packs should not be stored completely depleted of charge. The battery pack will need to be recharged before use.

Labels on Charger and Battery Pack

In addition to the pictographs used in this manual, the labels on the charger and the battery pack show the following pictographs:



Read instruction manual before use.



Charging.



Fully charged.



Hot/cold pack delay.



Problem pack or charger.



Problem powerline.



Do not probe with conductive objects.



Do not charge damaged battery packs.



Use only with DEWALT battery packs. Others may burst, causing personal injury and damage.



Do not expose to water.



Have defective cords replaced immediately.



Charge only between 4 °C and 40 °C.



Discard the battery pack with due care for the environment.

LI-ION



Do not incinerate the battery pack.



Li Ion Charges Li-Ion battery packs.



See **Technical Data** for charging time.



Only for indoor use.

Package Contents

The package contains:

- 1 Adaptor for all blades
- 1 31 mm x 43 mm Fastcut wood blade
- 1 Sanding-pad
- 1 31 mm x 43 mm Wood with nails blade
- 1 Rigid scraper blade
- 1 Blade adaptor hex key
- 1 Instruction manual
- 1 Exploded drawing

**DCS355D2/DCS355M2 ONLY:

- 1 Dust extraction adaptor**
- 1 Cutting guide**
- 1 100 mm Semicircle blade**

ENGLISH

- 25 Assorted sandpaper pieces**
- 1 9.5 mm x 43 mm Wood detail blade**
 - 1 3 mm Carbide grout removal blade** (100 mm half moon)
 - 1 Cutting guide hex key**
 - 1 Charger**
 - 2 Li-Ion battery packs**
 - 1 TStak kitbox**

NOTE: Battery packs, chargers and kitboxes are not included with N-models.

- Check for damage to the tool, parts or accessories which may have occurred during transport.
- Take the time to thoroughly read and understand this manual prior to operation.

Description (fig. 1, 2)



WARNING: Never modify the power tool or any part of it. Damage or personal injury could result.

- a. Variable speed trigger
- b. LED Worklight
- c. Accessory clamp lever
- d. Lock on/off button
- e. Accessory side mount slots
- f. Cut guide block
- g. Cut guide arm
- h. Battery pack
- i. Battery release button
- j. Fuel gauge button

INTENDED USE

This oscillating multi-tool is designed for professional detail sanding, plunge cutting, flush cutting, removal of excess materials and surface preparation applications.

DO NOT use under wet conditions or in the presence of flammable liquids or gases.

This oscillating multi-tool is a professional power tool.

DO NOT let children come into contact with the tool. Supervision is required when inexperienced operators use this tool.

- This product is not intended for use by persons (including children) suffering from diminished physical, sensory or mental abilities; lack of experience, knowledge or skills unless they are supervised by a person responsible for their safety. Children should never be left alone with this product.

Electrical Safety

The electric motor has been designed for one voltage only. Always check that the battery pack voltage corresponds to the voltage on the rating plate. Also make sure that the voltage of your charger corresponds to that of your mains.



Your DEWALT charger is double insulated in accordance with EN 60335; therefore no earth wire is required.

If the supply cord is damaged, it must be replaced by a specially prepared cord available through the DEWALT service organisation.

Mains Plug Replacement (U.K. & Ireland Only)

If a new mains plug needs to be fitted:

- Safely dispose of the old plug.
- Connect the brown lead to the live terminal in the plug.
- Connect the blue lead to the neutral terminal.



WARNING: No connection is to be made to the earth terminal.

Follow the fitting instructions supplied with good quality plugs. Recommended fuse: 3 A.

Using an Extension Cable

An extension cord should not be used unless absolutely necessary. Use an approved extension cable suitable for the power input of your charger (see **Technical Data**). The minimum conductor size is 1 mm²; the maximum length is 30 m.

When using a cable reel, always unwind the cable completely.

ASSEMBLY AND ADJUSTMENTS



WARNING: Prior to assembly and adjustment, always remove the battery pack. Always switch off the tool before inserting or removing the battery pack. Be sure the trigger switch is in the OFF position. An accidental start-up can cause injury.



WARNING: Risk of lacerations or burns. Do not touch the sharp edges of accessories at any time. Do not touch workpiece or blade immediately after operating the tool. They can become very hot. Handle carefully. Always allow accessories and workpiece to cool before handling.



WARNING: Use only DEWALT battery packs and chargers.

Inserting and Removing the Battery Pack from the Tool (fig. 2)

NOTE: For best results, make sure your battery pack is fully charged.

TO INSTALL THE BATTERY PACK INTO THE TOOL HANDLE

1. Align the battery pack (h) with the rails inside the tool's handle (fig. 2).
2. Slide it into the handle until the battery pack is firmly seated in the tool and ensure that it does not disengage.

TO REMOVE THE BATTERY PACK FROM THE TOOL

1. Press the battery release button (i) and firmly pull the battery pack out of the tool handle.
2. Insert battery pack into the charger as described in the charger section of this manual.

FUEL GAUGE BATTERY PACKS (FIG. 2)

Some DEWALT battery packs include a fuel gauge which consists of three green LED lights that indicate the level of charge remaining in the battery pack.

To actuate the fuel gauge, press and hold the fuel gauge button (j). A combination of the three green LED lights will illuminate designating the level of charge left. When the level of charge in the battery is below the usable limit, the fuel gauge will not illuminate and the battery will need to be recharged.

NOTE: The fuel gauge is only an indication of the charge left on the battery pack. It does not indicate tool functionality and is subject to variation based on product components, temperature and end-user application.

Installing/Removing Accessories (fig. 3–7)

TOOL-FREE ACCESSORY CLAMP (FIG. 3–5)

The DCS355 features a quick change accessory system. This allows for faster accessory changes without the need for wrenches or hex keys like other oscillating tool systems.

1. Grasp the tool and squeeze the accessory clamping lever (c) as shown in figure 3.
2. Clean any residual debris from the tool shaft and the accessory holder.
3. Slide the accessory between the shaft (v) and the accessory holder making sure the accessory engages all eight pins on the holder

and is flush with the shaft. Ensure the accessory is oriented as shown in figure 4.

4. Release the accessory clamp lever.

NOTE: Some accessories, such as scrapers and blades can be mounted at an angle if required as shown in figure 5.

INSTALLING/REMOVING SANDING SHEETS (FIG. 6)

A diamond shaped platen uses a hook and loop adhesion system to attach the sanding sheets. The platen allows you to use it on large flat surfaces and tight spots or corners.

1. Attach the sanding platen (w) as described under **Installing/Removing Accessories**.
2. Align the edges on the sanding sheet, with the edge of the sanding platen and press the sanding sheet (x) onto the platen.
3. Firmly press the base with the sanding sheet attached against a flat surface and briefly switch the tool on. This provides for good adhesion between the platen and the sanding sheet and also helps to prevent premature wear.
4. When the tip of the sanding sheet becomes worn, detach the sheet from the platen, rotate and reapply.

ATTACHING ACCESSORIES USING THE UNIVERSAL ADAPTER (FIG. 7)



CAUTION: To avoid injury, do not use any accessory for an application where the adaptor may fail to hold the accessory.



CAUTION: Read and follow all manufacturers' safety warnings for any accessories used with this tool.



CAUTION: To avoid injury, ensure adaptor and accessory are securely tightened.

Non-DEWALT accessories can be attached using the universal adaptor.

1. Place the washer (k) on the tool.
2. Place accessory (l) on to washer.
3. Tighten and secure adaptor nut (p) using hex wrench (r).

Attaching the Cut Guide (fig. 8–13)

The depth/cut guide allows you to precisely cut material at a specified depth and more accurately track a marked cut line.

ENGLISH

1. Attach the cut guide block (f) by inserting the accessory tabs (m) on the guide into the accessory side mount slots (e) on the main body of the tool.

NOTE: The depth/cut guide can be attached to either side of the tool.

2. Secure the block to the main body with the supplied screw (o) and washer (u). Tighten with the supplied hex wrench (p).

DEPTH GUIDE

This feature allows you to precisely cut material at a specified depth.

1. Insert the guide arm (g) as shown in figure 9 into the front slot on the guide block (f).
2. Adjust the length of the guide by pulling out or pushing inward to achieve the desired cut depth as shown in figure 10.
3. Secure the guide in place by turning the depth/cut adjustment knob (n) clockwise. To release the guide turn the depth/cut adjustment knob counterclockwise.

CUT GUIDE

This feature allows you to more accurately track a marked cut line.

1. Insert the guide arm (g) as shown in figure 11 into the slots on the left and right sides of the guide block (f).
2. Adjust the length of the guide by pulling out or pushing inward to achieve the desired length as shown in figure 12.
3. Secure the guide in place by turning the depth/cut adjustment knob (n) clockwise. To release the guide turn the depth/cut adjustment knob counterclockwise.

NOTE: The guide arm can also be placed in the guard assembly vertically in order to set the height off a cut. Refer to figure 13.

Attaching the Dust Extraction Adaptor (fig. 17)

The Dust Extraction Adaptor allows you to connect the tool to an external dust extractor, either using the AirLock™ system (DWV9000-XJ), or a standard 35 mm dust extractor fitment.

1. Attach the dust extraction adaptor (q) by inserting the tabs (m) in to the accessory side mount slots (e).

NOTE: The dust extraction adaptor can be attached to either side of the tool.

2. Insert screw (o) and washer (u) into the dust extraction adaptor (q) and tighten with the supplied hex key (p).

OPERATION

Instructions for Use (fig. 14, 15)



WARNING: Always observe the safety instructions and applicable regulations.



WARNING: To reduce the risk of serious personal injury, turn tool off and disconnect battery pack before making any adjustments or removing/installing attachments or accessories. An accidental start-up can cause injury.



WARNING: Ensure switch is fully OFF before installing the battery.

1. Install the battery pack.
2. To turn the tool ON, hold it as shown in figure 14 and press the variable speed trigger (a).

NOTE: The further the trigger switch is depressed the faster the tool will operate. If in doubt about the proper speed for your operation, test the performance at low speed and gradually increase until a comfortable speed is found.

3. To turn the tool OFF, release the variable speed trigger (a).

Lock on/off Button (fig. 15)

The tool can be locked off by fully depressing the lock on/off button (d) shown in figure 15.

For more comfort in extended use applications, the lock on/off button (d) can lock the trigger (a) in the depressed position.

LED Worklight (fig. 16)

The LED worklight (b) will activate when the trigger is depressed. It will automatically shut off following a short period of time once the trigger is released.

Proper Hand Position (fig. 14)



WARNING: To reduce the risk of serious personal injury, **ALWAYS** use proper hand position as shown.



WARNING: To reduce the risk of serious personal injury, **ALWAYS** hold securely in anticipation of a sudden reaction.

Proper hand position requires the tool to be held as shown in figure 14.

Using the Dust Extraction Adaptor with the Sanding Platen (fig. 18)

1. Attach the dust extraction adaptor (q). Refer to **Attaching the Dust Extraction Adaptor**.
2. Attach the sanding platen (w) as described under **Installing/Removing Accessories**.
3. Attach sanding sheet as described under **Installing/Removing Sanding Sheets**.

Using the Dust Extraction Adaptor with Plunge Cutting Accessory (fig. 19)

1. Attach the dust extraction adaptor. Refer to **Attaching the Dust Extraction Adaptor**.
2. Push dust extraction arm (s) into the lower aperture of the dust extraction adaptor (q).
3. Attach plunge cutting blade as described under **Installing/Removing Accessories**.
4. Adjust the dust extraction arm (s) for best results.

Helpful Hints

- Always ensure the workpiece is firmly held or clamped to prevent movement. Any movement of the material may affect the quality of the cutting or sanding finish.
- Do not start sanding without having the sandpaper attached to sanding platen.
- Use coarse grit paper to sand rough surfaces, medium grit for smooth surfaces and fine grit for the finishing surfaces. If necessary, first make a test run on scrap material.
- Excessive force will reduce the working efficiency and cause motor overload. Replacing the accessory regularly will maintain optimum working efficiency.
- Do not allow the sandpaper to wear away, it will damage the sanding pad.
- If the tool overheats, especially when used at low speed, set the speed to maximum and run it with no load for 2–3 minutes to cool the motor. Avoid prolonged usage at very low speeds. Always keep the blade sharp.

MAINTENANCE

Your DEWALT power tool has been designed to operate over a long period of time with a minimum of maintenance. Continuous satisfactory operation depends upon proper tool care and regular cleaning.



WARNING: To reduce the risk of serious personal injury, turn tool off and disconnect battery pack before making any adjustments or removing/installing attachments or accessories. Be sure the trigger switch is in the OFF position. An accidental start-up can cause injury.

The charger and battery pack are not serviceable. There are no serviceable parts inside.



Lubrication

Your power tool requires no additional lubrication.



Cleaning



WARNING: Blow dirt and dust out of the main housing with dry air as often as dirt is seen collecting in and around the air vents. Wear approved eye protection and approved dust mask when performing this procedure.



WARNING: Never use solvents or other harsh chemicals for cleaning the non-metallic parts of the tool. These chemicals may weaken the materials used in these parts. Use a cloth dampened only with water and mild soap. Never let any liquid get inside the tool; never immerse any part of the tool into a liquid.

CHARGER CLEANING INSTRUCTIONS



WARNING: Shock hazard. Disconnect the charger from the AC outlet before cleaning. Dirt and grease may be removed from the exterior of the charger using a cloth or soft non-metallic brush. Do not use water or any cleaning solutions.

Optional Accessories



WARNING: Since accessories, other than those offered by DEWALT, have not been tested with this product, use of such accessories with this tool could be hazardous. To reduce the risk of injury, only DEWALT, recommended accessories should be used with this product.

Consult your dealer for further information on the appropriate accessories.

COMPATIBLE ACCESSORIES

- Oscillating sanding pad
- Oscillating wood w/ nails blade
- Wide titanium oscillating wood w/ nails blade
- Oscillating hardwood blade
- Oscillating fastcut wood blade
- Wide oscillating fastcut wood blade
- Oscillating wood detail blade
- Oscillating titanium metal blade
- Oscillating semicircle blade
- Oscillating titanium semicircle blade
- Oscillating flush cut blade
- Titanium oscillating flush cut blade
- Oscillating multi-material blade
- Oscillating rigid scraper blade
- Oscillating flexible scraper blade
- Oscillating carbide grout removal blade
- Oscillating fastcut carbide grout removal blade
- Oscillating carbide rasp

Protecting the Environment



Separate collection. This product must not be disposed of with normal household waste.

Should you find one day that your DEWALT product needs replacement, or if it is of no further use to you, do not dispose of it with household waste. Make this product available for separate collection.



Separate collection of used products and packaging allows materials to be recycled and used again. Re-use of recycled materials helps prevent environmental pollution and reduces the demand for raw materials.

Local regulations may provide for separate collection of electrical products from the household, at municipal waste sites or by the retailer when you purchase a new product.

DEWALT provides a facility for the collection and recycling of DEWALT products once they have reached the end of their working life. To take advantage of this service please return your product to any authorised repair agent who will collect them on our behalf.

You can check the location of your nearest authorised repair agent by contacting your local DEWALT office at the address indicated in this manual. Alternatively, a list of authorised DEWALT repair agents and full details of our after-sales service and contacts are available on the Internet at: www.2helpU.com.



Rechargeable Battery Pack

This long life battery pack must be recharged when it fails to produce sufficient power on jobs which were easily done before. At the end of its technical life, discard it with due care for our environment:

- Run the battery pack down completely, then remove it from the tool.
- Li-Ion cells are recyclable. Take them to your dealer or a local recycling station. The collected battery packs will be recycled or disposed of properly.

GUARANTEE

DEWALT is confident of the quality of its products and offers an outstanding guarantee for professional users of the product. This guarantee statement is in addition to and in no way prejudices your contractual rights as a professional user or your statutory rights as a private non-professional user. The guarantee is valid within the territories of the Member States of the European Union and the European Free Trade Area.

• 30 DAY NO RISK SATISFACTION GUARANTEE •

If you are not completely satisfied with the performance of your DEWALT tool, simply return it within 30 days, complete with all original components, as purchased, to the point of purchase, for a full refund or exchange. The product must have been subject to fair wear and tear and proof of purchase must be produced.

• ONE YEAR FREE SERVICE CONTRACT •

If you need maintenance or service for your DEWALT tool, in the 12 months following purchase, you are entitled to one service free of charge. It will be undertaken free of charge at an authorised DEWALT repair agent. Proof of purchase must be produced. Includes labour. Excludes accessories and spare parts unless failed under warranty.

• ONE YEAR FULL WARRANTY •

If your DEWALT product becomes defective due to faulty materials or workmanship within 12 months from the date of purchase, DEWALT guarantees to replace all defective parts free of charge or – at our discretion – replace the unit free of charge provided that:

- The product has not been misused;
- The product has been subject to fair wear and tear;
- Repairs have not been attempted by unauthorised persons;
- Proof of purchase is produced;
- The product is returned complete with all original components.

If you wish to make a claim, contact your seller or check the location of your nearest authorised DEWALT repair agent in the DEWALT catalogue or contact your DEWALT office at the address indicated in this manual. A list of authorised DEWALT repair agents and full details of our after-sales service is available on the Internet at: www.2helpU.com.

ENGLISH

TROUBLESHOOTING

PROBLEM	POSSIBLE CAUSE	POSSIBLE SOLUTION
Unit will not start.	Battery not installed correctly.	Install battery in tool handle and ensure it is seated correctly.
	Battery is not charged.	Place battery on charger and install a fully charged battery pack in tool.
	Battery or power tool is overheated.	Allow battery and/or tool to cool after extended use or replace overheated battery pack with a cool one.
	Switch is damaged.	Have switch replaced by an authorised DEWALT repair agent.